

RA LINE



cmatic[®]
P N E U M A T I C F I T T I N G S

Raccordi Standard in Ottone Nichelato
Brass Nickel-Plated Standard Fittings
Raccords Standard en laiton nickelé
Standardverschraubungen aus Messing vernickelt



I

La serie RA, comunemente considerata come una serie di "Accessori" o "Raccordi Standard", è costituita da Nippli, Riduzioni, Prolunghe, Tappi, Portagomma, Raccordi a L, Raccordi a T, Croci, ecc.

Vista la varietà di funzioni ausiliarie che coprono questi raccordi, risulta evidente il ruolo di completamento, che questa serie svolge nei confronti delle altre.

Tutti i raccordi RA vengono sottoposti a trattamento superficiale di Nichelatura.

The RA line, also known as the "Accessories line" or the "Standard fittings line" consists of a wide variety of components, such as Nipples, Reduction pieces, Connections, Plugs, Hose connections, L-T and Cross fittings.

Due to the multiple auxiliary functions of this line, the RA fittings are the right complement for other ranges.

All components are brass nickel-plated.

GB

La série RA, ou bien "La série des accessoires, ou Raccords Standard" se compose d'une grande variété de pièces pour tous raccordements et toutes configurations: mamelons, pièces de réduction, bouchons, douilles cannelées, raccords en Té, en L et Croix.

Compte tenu de la variété de ses fonctions complémentaires, la principale caractéristique de cette série devient celle de bien compléter les autres gammes.

Tous les raccords de cette série sont en laiton nickelé.

F

Die RA Baureihe, bekannt als die "Zubehörsérie" oder die "Standardverschraubungsbaureihe" besteht aus Verschraubungen aller Bauformen und Größen wie Nippel, Reduzierstück, Stopfen, Schlauchfüllen, T, L-Stueck, Winkel-und-Kreuzverschraubungen.

Es ist eine umfangreiche Nebenfunktionsserie, die als Programmergänzung zu den anderen Baureihen betrachtet werden muss.

Alle Teile sind aus Messing vernickelt.

D

1	2
Corpo del raccordo Fitting Body Corps du raccord Verschraubungskörper	Guarnizioni Seals Joint d'étanchéité Dichtung
Ottone UNI EN 12164 CW614N - UNI EN 12165 CW617N Nichelato Brass UNI EN 12164 CW614N - UNI EN 12165 CW617N Nickel Plated Laiton UNI EN 12164 CW614N - UNI EN 12165 CW617N Nickelé Messing UNI EN 12164 CW614N - UNI EN 12165 CW617N vernickelt	NBR NBR NBR NBR



-40°C ÷ 150°C



Max 60 bar

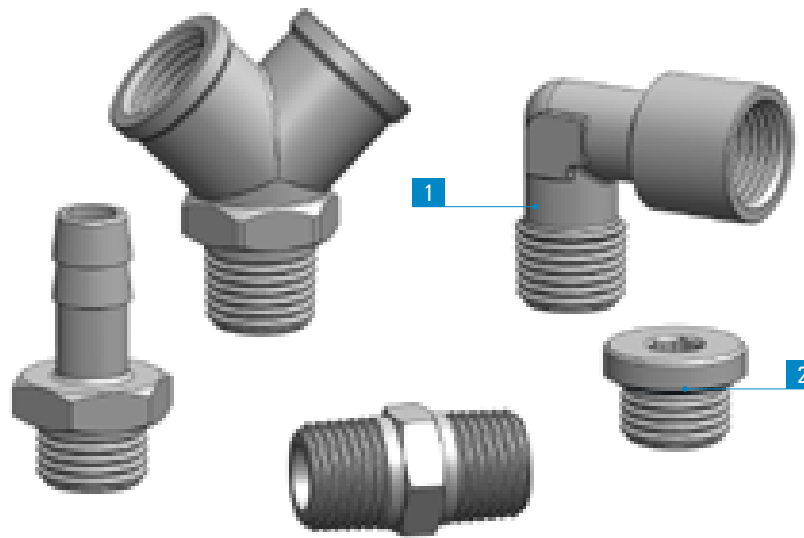

	M5x0,8	G1/8	G1/4	G3/8	G1/2	G3/4	G1"	R1/8	R1/4	R3/8	R1/2	R3/4	R1"
--	--------	------	------	------	------	------	-----	------	------	------	------	------	-----

Campi di applicazione:
 Impianti pneumatici, idraulici ed oleodinamici.

Application fields:
 Pneumatic, hydraulic and oleodynamic circuits.

Domaines d'application:
 Circuits pneumatiques, hydrauliques et oléodynamiques.

Anwendungsbereiche:
 Hydraulische, öldynamische und pneumatische Anlagen.

RA 11

Nipplo cilindrico

Nipple, parallel

Mamelon cylindrique

Doppelnippel, zylindrisch

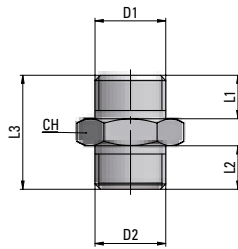

Type	D1	D2	L1	L2	L3	CH	g Δ
11 M5 M5	M5x0,8	M5x0,8	5	5	13,5	8	2
11 M5 18	M5x0,8	G1/8	4	6	14,5	14	8
11 18 18	G1/8	G1/8	6	6	16,5	14	8
11 18 14	G1/8	G1/4	6	8	19	17	16,2
11 18 38	G1/8	G3/8	6	9	20	19	19
11 14 14	G1/4	G1/4	8	8	21	17	18,8
11 14 38	G1/4	G3/8	8	9	22	19	23,5
11 14 12	G1/4	G1/2	8	10	23,5	24	32
11 38 38	G3/8	G3/8	9	9	23	19	23
11 38 12	G3/8	G1/2	9	10	24,5	24	31,8
11 12 12	G1/2	G1/2	10	10	25,5	24	35

RA 12

Nipplo conico

Nipple, taper

Mamelon conique

Doppelnippel, kegelig

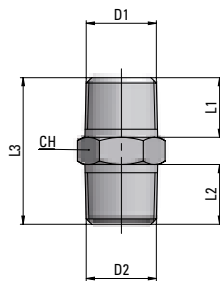

Type	D1	D2	L1	L2	L3	CH	g Δ
12 18 18	R1/8	R1/8	7,5	7,5	19,5	12	8
12 18 14	R1/8	R1/4	8	11	24	14	14,4
12 18 38	R1/8	R3/8	8	11,5	24,5	17	20
12 14 14	R1/4	R1/4	11	11	27	14	15,2
12 14 38	R1/4	R3/8	11	11,5	27,5	17	20,4
12 14 12	R1/4	R1/2	11	14	30,5	22	35,6
12 38 38	R3/8	R3/8	11,5	11,5	28	17	25,1
12 38 12	R3/8	R1/2	11,5	14	31	22	38,5
12 12 12	R1/2	R1/2	14	14	33,5	22	41,8
12 12 34	R1/2	R3/4	14	16,5	37	27	69
12 34 34	R3/4	R3/4	16,5	16,5	39,5	27	78,9
12 34 1	R3/4	R1"	16,5	19	42,5	34	112,4
12 1 1	R1"	R1"	19	19	45,5	34	127,5

RA 13

Manicotto

Joint piece

Manchon

Muffe

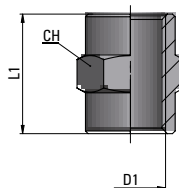

Type	D1	L1	CH	g Δ
13 00 M5	M5x0,8	11	8	2
13 00 18	G1/8	15	14	9,8
13 00 14	G1/4	22	17	19,1
13 00 38	G3/8	23	22	34,5
13 00 12	G1/2	28	26	48,4
13 00 34	G3/4	32	32	98,4
13 00 1	G1"	35	38	97,8

RA 14

Riduzione F-M conica

Taper female-male reducing connector

Réduction femelle-mâle, conique

Reduzierstück, Auf-Einschraub, kegelig

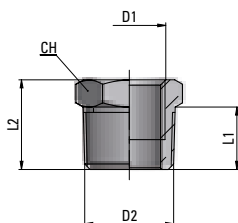

Type	D1	D2	L1	L2	CH	g Δ
14 18 14	G1/8	R1/4	11	16	14	10,2
14 18 38	G1/8	R3/8	11,5	16,5	17	20,2
14 18 12	G1/8	R1/2	14	19,5	22	34,8
14 14 38	G1/4	R3/8	11,5	16,5	17	15
14 14 12	G1/4	R1/2	14	19,5	22	31,5
14 38 12	G3/8	R1/2	14	19,5	22	24,1
14 38 34	G3/8	R3/4	16,5	23	27	70
14 12 34	G1/2	R3/4	16,5	23	27	44,6
14 12 1	G1/2	R1"	19	27	34	102,5
14 34 1	G3/4	R1"	19	27	34	74,2

RA 15

Riduzione F-M cilindrica

Parallel female-male reducing connector

Réduction femelle-mâle, cylindrique

Reduzierstück, Auf-Einschraub, zylindrisch

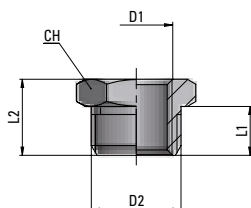

Type	D1	D2	L1	L2	CH	g Δ
15 M5 18	M5x0,8	G1/8	6	10,5	14	8
15 18 14	G1/8	G1/4	8	13	17	10,5
15 18 38	G1/8	G3/8	9	14	19	19,3
15 18 12	G1/8	G1/2	10	15,5	24	30,7
15 14 38	G1/4	G3/8	9	14	19	12,8
15 14 12	G1/4	G1/2	10	15,5	24	28,5
15 38 12	G3/8	G1/2	10	15,5	24	22
15 38 34	G3/8	G3/4	11	17,5	30	-
15 12 34	G1/2	G3/4	11	17,5	30	36
15 34 1	G3/4	G1"	11,5	18,5	36	60,3

RA 16

Prolunga M-F conica

Adaptor male-female, taper

Réduction mâle-femelle, conique

Reduziernippel, Ein-Aufschraub, kegelig

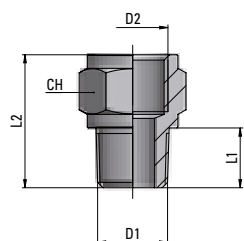

Type	D1	D2	L1	L2	CH	g Δ
16 18 18	R1/8	G1/8	8	18	14	11,1
16 18 14	R1/8	G1/4	8	21,5	17	18
16 18 38	R1/8	G3/8	8	22,5	22	29,8
16 14 14	R1/4	G1/4	11	24,5	17	20,5
16 14 38	R1/4	G3/8	11	25,5	22	42
16 14 12	R1/4	G1/2	11	29	24	40
16 38 38	R3/8	G3/8	11,5	26	22	42
16 38 12	R3/8	G1/2	11,5	29,5	24	40
16 12 12	R1/2	G1/2	14	32	26	57

RA 17

Prolunga M-F cilindrica

Adaptor male-female, parallel

Réduction mâle-femelle, cylindrique

Reduziernippel, Ein-Aufschraub, zylindrisch

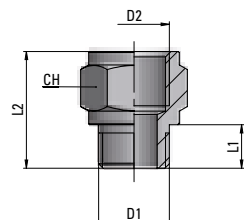

Type	D1	D2	L1	L2	CH	g Δ
17 M5 18	M5x0,8	G1/8	4	14,5	14	7
17 18 18	G1/8	G1/8	6	16,5	14	10,7
17 18 14	G1/8	G1/4	6	19,5	17	17
17 18 38	G1/8	G3/8	6	20,5	22	29,5
17 14 14	G1/4	G1/4	8	21,5	17	19
17 14 38	G1/4	G3/8	8	22,5	22	32
17 14 12	G1/4	G1/2	8	26	24	37
17 38 38	G3/8	G3/8	9	23,5	22	36
17 38 12	G3/8	G1/2	9	27	24	37
17 12 12	G1/2	G1/2	10	28	26	52,5

RA 18

Manicotto ridotto

Reduction joint piece

Manchon de réduction

Reduziermuffe

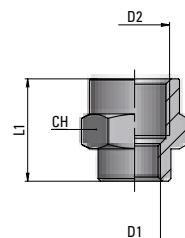

Type	D1	D2	L1	CH	g Δ
18 M5 18	M5x0,8	G1/8	13,5	14	10
18 18 14	G1/8	G1/4	19	17	18
18 18 38	G1/8	G3/8	20	22	36
18 14 38	G1/4	G3/8	22,5	22	41
18 14 12	G1/4	G1/2	26	24	46
18 38 12	G3/8	G1/2	26	24	35,5
18 12 34	G1/2	G3/4	30	32	82,1

RA 19

Tappo cilindrico

Parallel plug

Bouchon cylindrique

Verschlussstopfen, zylindrisch

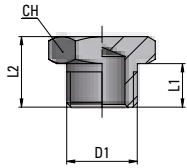

Type	D1	L1	L2	CH	g Δ
19 00 M5	M5x0,8	4	7	8	2
19 00 18	G1/8	6	10	14	7,5
19 00 14	G1/4	8	12,5	17	13,9
19 00 38	G3/8	9	13,5	19	18
19 00 12	G1/2	10	15,5	24	31
19 00 34	G3/4	11	16,5	30	48,9
19 00 1	G1	13	19	38	-

RA 20

Tappo femmina

Female plug

Bouchon femelle

Verschlusskappe, Aufschraub

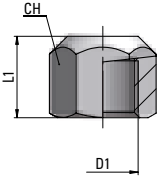

Type	D1	L1	CH	g Δ
20 00 18	G1/8	10	14	9,6
20 00 14	G1/4	13,5	17	16,7
20 00 38	G3/8	14	20	21,3
20 00 12	G1/2	16,5	24	31,3
20 00 34	G3/4	18,5	30	52,2
20 00 1	G1"	20	38	98,7

RA 21

Gomito F-F

Female elbow

Equerre femelle

Aufschraub-Winkel

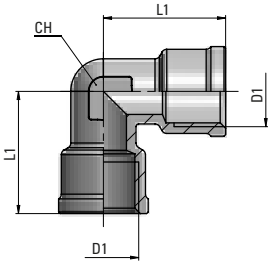

Type	D1	L1	CH	g Δ
21 18 18	G1/8	18,5	10	15
21 14 14	G1/4	22,5	12	38
21 38 38	G3/8	25,5	15	44,2
21 12 12	G1/2	30	19	73,2

RA 22

Gomito M-F

Male-female elbow

Equerre mâle-femelle

Auf-Einschraub-Winkel

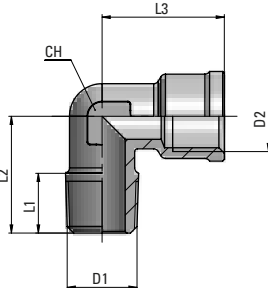

Type	D1	D2	L1	L2	L3	CH	g Δ
22 18 18	R1/8	G1/8	8,2	17	18,5	10	12,6
22 14 14	R1/4	G1/4	11	21,5	22,5	12	23,9
22 38 38	R3/8	G3/8	12	24,5	25,5	15	40,9
22 12 12	R1/2	G1/2	14	29,5	30	19	74,7
22 34 34	R3/4	G3/4	16	33	36,5	25	98,1
22 1 1	R1"	G1"	17	39	45	30	164

RA 23

T F-F-F

Female tee

Té femelle

T Aufsraub

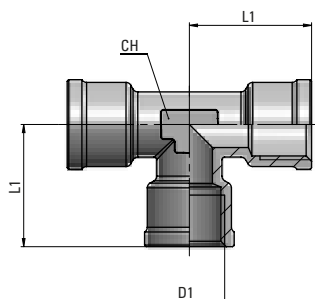

Type	D1	L1	CH	g Δ
23 18 18	G1/8	18,5	10	21
23 14 14	G1/4	22,5	12	36,6
23 38 38	G3/8	25,5	15	61,3
23 12 12	G1/2	30	19	98,2

RA 24

T F-M-F

Male-female stud tee

Té femelle-mâle-femelle

T Auf-Einschraub

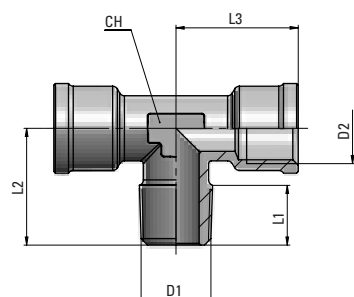

Type	D1	D2	L1	L2	L3	CH	g Δ
24 18 18	R1/8	G1/8	8,1	17	18,5	10	18,7
24 14 14	R1/4	G1/4	11	21,5	22,5	12	33,5
24 38 38	R3/8	G3/8	12	24,5	25,5	15	57,7
24 12 12	R1/2	G1/2	14	29,5	30	19	96,4
24 34 34	R3/4	G3/4	17	34,5	35,5	22	176,7
24 1 1	R1"	G1"	19	40,5	40,5	28	296,8

RA 25

T M-F-F

Male-female, lateral tee

Té mâle-femelle-femelle

T Ein-Aufsraub

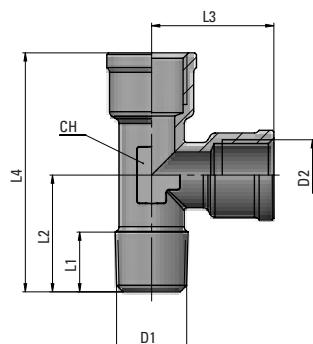

Type	D1	D2	L1	L2	L3	L4	CH	g Δ
25 18 18	R1/8	G1/8	8,2	17	18,5	35,5	10	18,7
25 14 14	R1/4	G1/4	11	21,5	22,5	44	12	34
25 38 38	R3/8	G3/8	12	24,5	25,5	50	15	57,5
25 12 12	R1/2	G1/2	14	29,5	30	59,5	19	95,9

RA 26

Croce femmina

Female cross

Croix femelle

Aufsraub-Kreuzstück

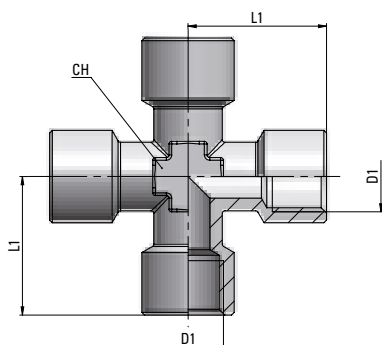

Type	D1	L1	CH	g Δ
26 18 18	G1/8	21	10	41
26 14 14	G1/4	25,5	13	73,9
26 38 38	G3/8	28	17	112

RA 27

Gomito M-F

Male-female elbow

Equerre mâle-femelle

Auf-Einschraub-Winkel

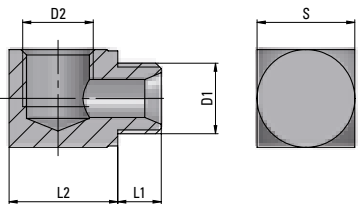

Type	D1	D2	L1	L2	S	g	ΔΔ
27 M5 M5	M5x0,8	M5x0,8	5	10	9	6	
27 18 18	G1/8	G1/8	6	14	13	14	
27 14 14	G1/4	G1/4	8	20	18	40	

RA 28

T F-M-F

Male-female stud tee

Té femelle-mâle-femelle

T Auf-Einschraub

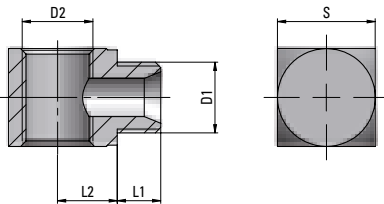

Type	D1	D2	L1	L2	S	g	ΔΔ
28 M5 M5	M5x0,8	M5x0,8	5	5,5	9	5	
28 18 18	G1/8	G1/8	6	7,5	13	6	
28 14 14	G1/4	G1/4	8	11	18	36	

RA 29

Ripartitore 4 vie

Manifold, 4 ways

Distributeur, 4 Voies

Verteilblock, 4 Wege

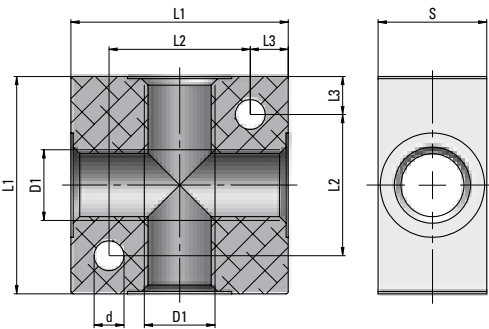

Type	D1	D2	L1	L2	L3	S	g	ΔΔ
29 00 M5	M5x0,8	3,2	20	14	3	10	9	
29 00 18	G1/8	4,5	25	17	4	16	18	
29 00 14	G1/4	5,5	40	26	7	20	64	
29 00 38	G3/8	5,5	50	34	8	25	125	
29 00 12	G1/2	5,5	50	34	8	30	130	

Il corpo è in Alluminio Anodizzato - The body is in Anodised Aluminium - Corps est en aluminium anodisé - Der Körper besteht aus eloxiertem Aluminium

RA 29 S

Ripartitore singolo

Manifold, single

Distributer, simple

Verteilblock, einfach

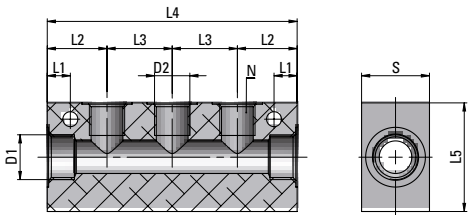

Type	D1	D2	N	L1	L2	L3	L4	L5	S	g	ΔΔ
29 14 18 S3	G1/4	G1/8	3	4,5	18	18	72	30	20	91,7	
29 14 18 S4	G1/4	G1/8	4	4,5	18	18	90	30	20	115,7	
29 14 18 S5	G1/4	G1/8	5	4,5	18	18	108	30	20	140,5	
29 38 14 S3	G3/8	G1/4	3	8,5	22	24	92	40	25	193,2	
29 38 14 S4	G3/8	G1/4	4	8,5	22	24	116	40	25	244,3	
29 38 14 S5	G3/8	G1/4	5	8,5	22	24	140	40	25	296,7	

Corpo in Alluminio non Anodizzato - Body in non-anodized Aluminium - Corps en Aluminium non anodisé - Gehäuse aus nicht eloxiertem Aluminium

RA 29 D

Ripartitore doppio

Manifold, double

Distributeur, double

Verteilblock, zweifach

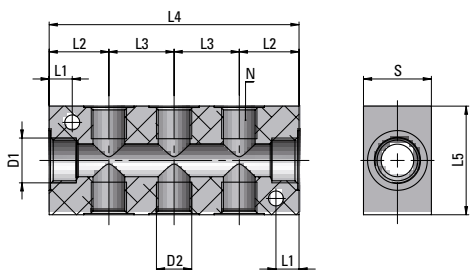

Type	D1	D2	N	L1	L2	L3	L4	L5	S	g Δ
29 14 18 D3	G1/4	G1/8	3+3	4,5	18	18	72	30	20	85,7
29 14 18 D4	G1/4	G1/8	4+4	4,5	18	18	90	30	20	107,6
29 14 18 D5	G1/4	G1/8	5+5	4,5	18	18	108	30	20	129,1
29 38 14 D3	G3/8	G1/4	3+3	8,5	22	24	92	40	25	179,4
29 38 14 D4	G3/8	G1/4	4+4	8,5	22	24	116	40	25	226,1
29 38 14 D5	G3/8	G1/4	5+5	8,5	22	24	140	40	25	274,1

Corpo in Alluminio non Anodizzato - Body in non-anodized Aluminum - Corps en Aluminium non anodisé - Gehäuse aus nicht eloxiertem Aluminium

RA 30

Portagomma

Hose connector

Douille cannelée

Schlauchtülle

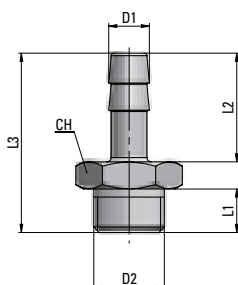

Type	D1	D2	L1	L2	L3	CH	g Δ
30 03 M5	3	M5x0,8	5	9	17	8	2
30 3,5 M5	3,5	M5x0,8	5	9	17	8	2
30 4,5 M5	4,5	M5x0,8	5	9	17	8	2,3
30 7,5 18	7,5	G1/8	6	20	30	14	9,9
30 7,5 14	7,5	G1/4	8	20	33	17	17
30 8,5 18	8,5	G1/8	6	20	30	14	11,5
30 8,5 18	8,5	G1/4	8	19	29,5	12	11,5
30 9,5 18	9,5	G1/8	6	20	30	14	11
30 9,5 14	9,5	G1/4	8	20	33	17	18
30 9,5 38	9,5	G3/8	9	20	34	19	22
30 12,5 14	12,5	G1/4	8	22	35	17	20,5
30 12,5 38	12,5	G3/8	9	22	36	19	22,9
30 12,5 12	12,5	G1/2	10	22	37,5	24	38
30 17,5 38	17,5	G3/8	9	24	38	19	30,2
30 17,5 12	17,5	G1/2	10	24	39	24	41,5

RA 31

Dado

Nut

Ecrou

Überwurfmutter

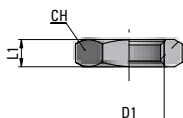

Type	D1	L1	CH	g Δ
31 00 18	G1/8	4,5	14	4
31 00 14	G1/4	5	17	5
31 00 38	G3/8	5,5	19	5
31 00 12	G1/2	6	24	8
31 00 M10x1	M10x1	4	14	3
31 00 M12x1	M12x1	5	16	5
31 00 M14x1	M14x1	5	18	5,5
31 00 M16x1	M16x1	5	20	6
31 00 M20x1,5	M20x1,5	4	27	10,5

RA 35

Gomito M-M

Male-male elbow

Equerre mâle

Einschraub-Winkelstück

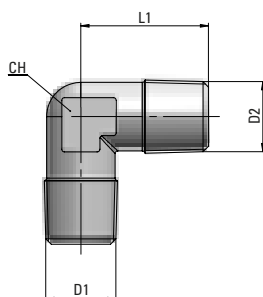

Type	D1	D2	L1	CH	g Δ
35 18 18	R1/8	R1/8	17	10	10,4
35 14 14	R1/4	R1/4	21,5	12	28,5
35 38 38	R3/8	R3/8	24,5	15	37,1
35 12 12	R1/2	R1/2	29,5	19	68,7
35 34 34	R3/4	R3/4	34,5	22	92,3
35 1 1	R1"	R1"	40,5	28	156

RA 36

T M-M-M

Male tee

Té mâle

Einschraub-T-Stück

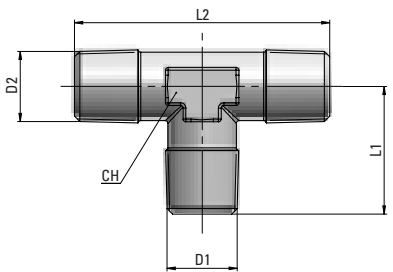

Type	∅ Tubo	D1	D2	L1	L2	g	Δ
36 18 18	R1/8	R1/8	17	34	10	14,3	
36 14 14	R1/4	R1/4	21,5	43	12	28,7	
36 38 38	R3/8	R3/8	24,5	49	15	50,6	
36 12 12	R1/2	R1/2	29,5	59	19	93	
36 34 34	R3/4	R3/4	34,5	69	22	138,6	
36 1 1	R1"	R1"	40,5	81	28	239,3	

RA 38

Riduzione a gomito M-M

Elbow reduction male-male

Réduction équerre, mâle-mâle

Einschraub-Reduzierstück

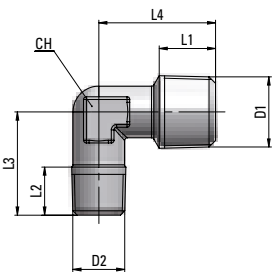

Type	D1	D2	L1	L2	L3	L4	CH	g	Δ
38 18 14	R1/4	R1/8	11	8	18,5	21,5	10	19	

RA 39

Prolunga M-F

Extention male-female

Prolongation mâle-femelle

Verlängerung M-F

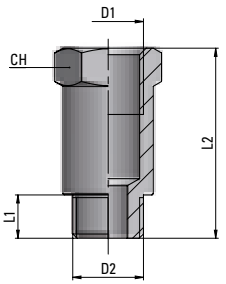

Type	D1	D2	L1	L2	CH	g	Δ
39 18 22	G1/8	G1/8	6	22	14	14	
39 18 42	G1/8	G1/8	6	42	14	28	
39 14 35	G1/4	G1/4	8	35	17	32	
39 14 51	G1/4	G1/4	8	51	17	46	

RA 40

Y F-F-F

Female Y

Y avec filétage intérieur

Y mit Innengewinde

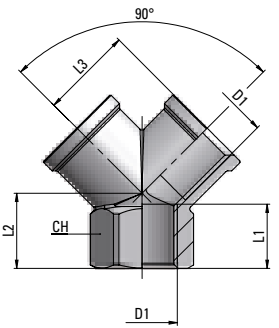

Type	D1	L1	L2	L3	CH	g	Δ
40 00 18	G1/8	8	12	14	13	18	
40 00 14	G1/4	11	14	17	17	34	
40 00 38	G3/8	11,5	16	19	20	45	
40 00 12	G1/2	14	19	24,5	25	90	

RA 41

Y M-F-F

Male female Y

Y avec filetage
intérieur/extérieur

Y mit Innen-Aussgewinde

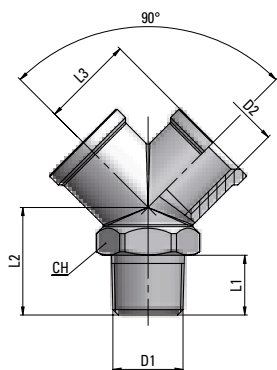

Type	D1	D2	L1	L2	L3	CH	g Δ
41 00 18	R1/8	G1/8	8	16	14	13	22
41 00 14	R1/4	G1/4	11	20	17	17	39
41 00 38	R3/8	G3/8	11,5	22	19	20	56
41 00 12	R1/2	G1/2	14	27	24,5	25	106

RA 42

Anello filettato

Single banjo ring

Bague orientable simple

Einfaches Schwenkringstück

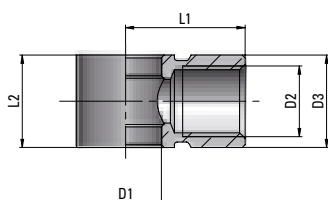

Type	D1	D2	D3	L1	L2	g Δ
42 00 M5	5,1	M5x0,8	9	11,5	10	9
42 00 18	10	G1/8	14	16	15	15
42 00 14	13,2	G1/4	17	22	17	26
42 00 38	17	G3/8	20,5	26	20	38
42 00 12	21	G1/2	25	32	24	66
42 00 M5 /R	7	M5x0,8	9	11,5	10	6

/R = Solo per regolatori di flusso - For flow controls only - Seulement pour les réducteurs de débit - Nur für Drosselrückschlagventil

RA 43

Tappo conico

Taper plug

Bouchon cône

Verschlussstopfen, kegelig

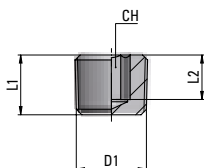

Type	D1	L1	L2	CH	g Δ
43 00 18	R1/8	7,5	4,8	5	3
43 00 14	R1/4	11	8	6	8
43 00 38	R3/8	11,5	7,6	8	14
43 00 12	R1/2	14	10,1	10	27
43 00 34	R3/4	15,5	10	14	45,5
43 00 1	R1"	17,5	11,5	17	84

RA 44

Passaparete filettato

Bulkhead connector

Traversée en cloison

Schottverschraubung

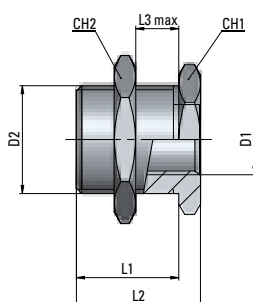

Type	D1	D2	L1	L2	L3	CH1	CH2	g Δ
44 00 M5	M5x0,5	M10x1	10,5	14	6	14	14	12
44 00 18	G1/8	M16x1,5	14	18	8	19	22	28
44 00 14	G1/4	M20x1,5	20	24	13	24	27	54,8
44 00 38	G3/8	M26x1,5	21	26	13	30	32	91
44 00 12	G1/2	M28x1,5	27	33	19	32	36	113,5

RA 45

T M-F-M

Male-female-male tee

Té mâle-femelle-mâle

T, Ein-Aufschraub

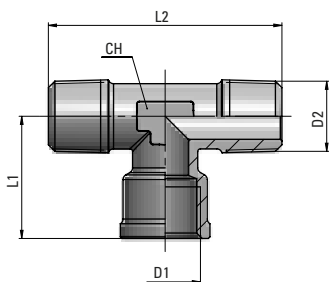

Type	D1	D2	L1	L2	CH	g Δ
45 18 18	G1/8	R1/8	18,5	34	10	16,6
45 14 14	G1/4	R1/4	22,5	43	12	31,3
45 38 38	G3/8	R3/8	25,5	49	15	64,5
45 12 12	G1/2	R1/2	30	59	19	95,4

RA 46

Tappo maschio con oring

Male plug with oring

Bouchon mâle avec oring

Einschraubstopfen mit Oring

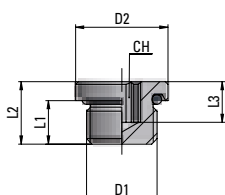

Type	D1	D2	L1	L2	L3	CH	g Δ
46 00 18	G1/8	14	6,5	9,5	5,5	5	5,5
46 00 14	G1/4	17	8	11,5	6,5	6	11,5
46 00 38	G3/8	20	9	12,5	6	8	17,8
46 00 12	G1/2	26	10	14	7	10	33

Guarnizioni NBR - NBR Seals - Joint d'étanchéité NBR - NBR Dichtung

RA 47

T M-F-M

Male-female-male tee

Té mâle-femelle-mâle

T, Ein-Aufschraub

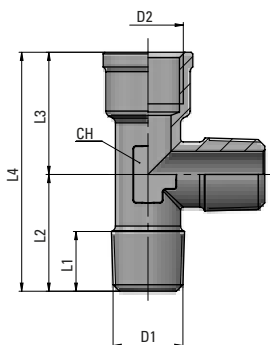

Type	D1	D2	L1	L2	L3	L4	CH	g Δ
47 18 18	R1/8	G1/8	8,2	17	18,5	35,5	10	16,7
47 14 14	R1/4	G1/4	11	21,5	22,5	44	12	31,2
47 38 38	R3/8	G3/8	12	24,5	25,5	50	15	53,8
47 12 12	R1/2	G1/2	14	29,5	30	59,5	19	94,7

RA 94

Rondella in plastica PA6

PA6 sealing ring

Bague étanchéité en PA6

PA6 Dichtring

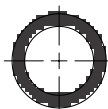
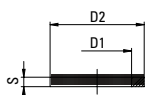

Type	D1	D2	S	g Δ
94 00 M5	5	8	1,2	0,1
94 00 18	9,9	13,9	1,8	0,2
94 00 14	13,1	17,9	1,8	0,3
94 00 38	16,8	21,4	1,8	0,3
94 00 12	21	25,4	2	0,4

RA 95

Rondella in plastica PA6,
imperdibile

PA6 toothed sealing ring

Bague étancheité en PA6,
imperdable

PA6 Dichtring, unverlierbar

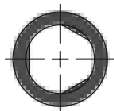
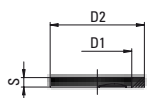

Type	D1	D2	S	g
95 00 M5	5	8	1,2	0,1
95 00 18	9,9	13,9	1,8	0,2
95 00 14	13,1	17,9	1,8	0,3
95 00 38	16,8	21,4	1,8	0,3
95 00 12	21	25,4	2	0,4

RA 96

Rondella di tenuta in alluminio

Aluminium sealing washer

Bague étancheité en aluminium

Aluminiumdichtring

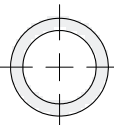
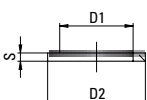

Type	D1	D2	S	g
96 00 M5	5	9	1	0
96 00 18	10,2	14	1,5	0,3
96 00 14	13,5	18	1,5	0,4
96 00 38	17	22	1,5	0,5
96 00 12	21,5	27	1,5	0,8

RA 97

Rondella di tenuta in PTFE

PTFE sealing ring

Bague étancheité en PTFE

PTFE Dichtring

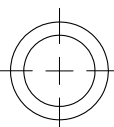

Type	D1	D2	S	g
97 00 18	10,1	14	2	0,3
97 00 14	13,1	18	2	0,4
97 00 38	16,8	21,4	1,8	0,6
97 00 12	21	25,5	2	0,8

RA 98

Rondella di tenuta acciaio/NBR

Bonded seal

Bagues BS

Stahldichtringe mit NBR Einlage

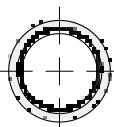
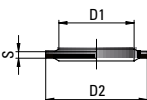

Type	D1	D2	S	g
98 00 18	10,4	14,7	1,2	0,6
98 00 14	13,85	18,7	1,2	0,8
98 00 38	17,35	22,7	1,2	1,1
98 00 12	21,65	26,7	1,2	1,2
98 00 34	27,3	32,6	1,2	1,5

RA 99

Rondella di tenuta acciaio/NBR
con autocentraggio

Bonded seal, self centring

Bagues BS avec auto centrage

Stahldichtringe mit NBR Einlage, selbst-
zentrierend

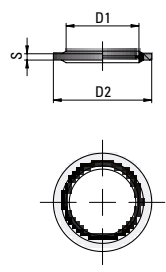

Type	D1	D2	S	g Δ
99 00 M5	5,7	9	1	0,2
99 00 18	10,37	15,88	2	1,6
99 00 14	13,74	20,57	2	2,7
99 00 38	17,28	23,80	2	3
99 00 12	21,54	28,58	2,5	4,6
99 00 34	27,05	34,93	2,5	6,8